

**PORTA AD 1 ANTA ISOSTAHL 50
REI 30 e REI 60**

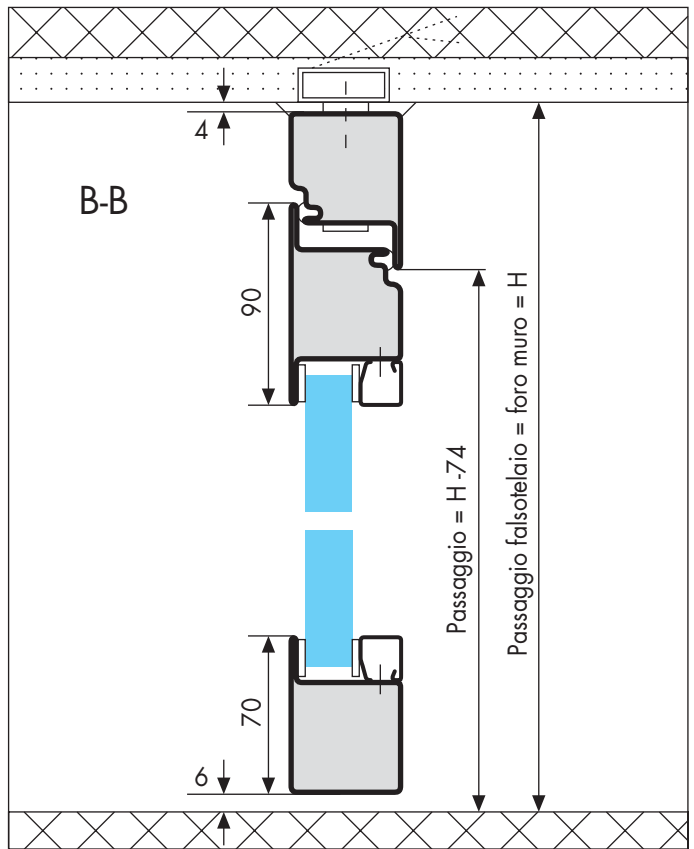

MONTAGGIO IN LUCE

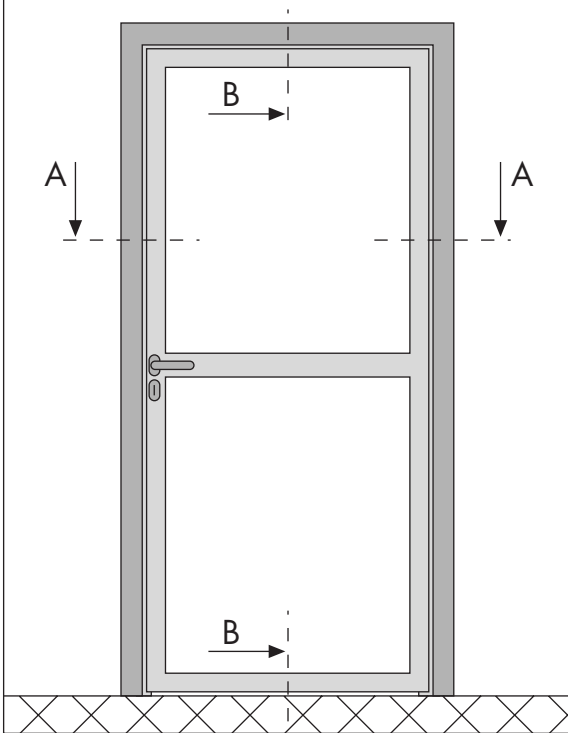
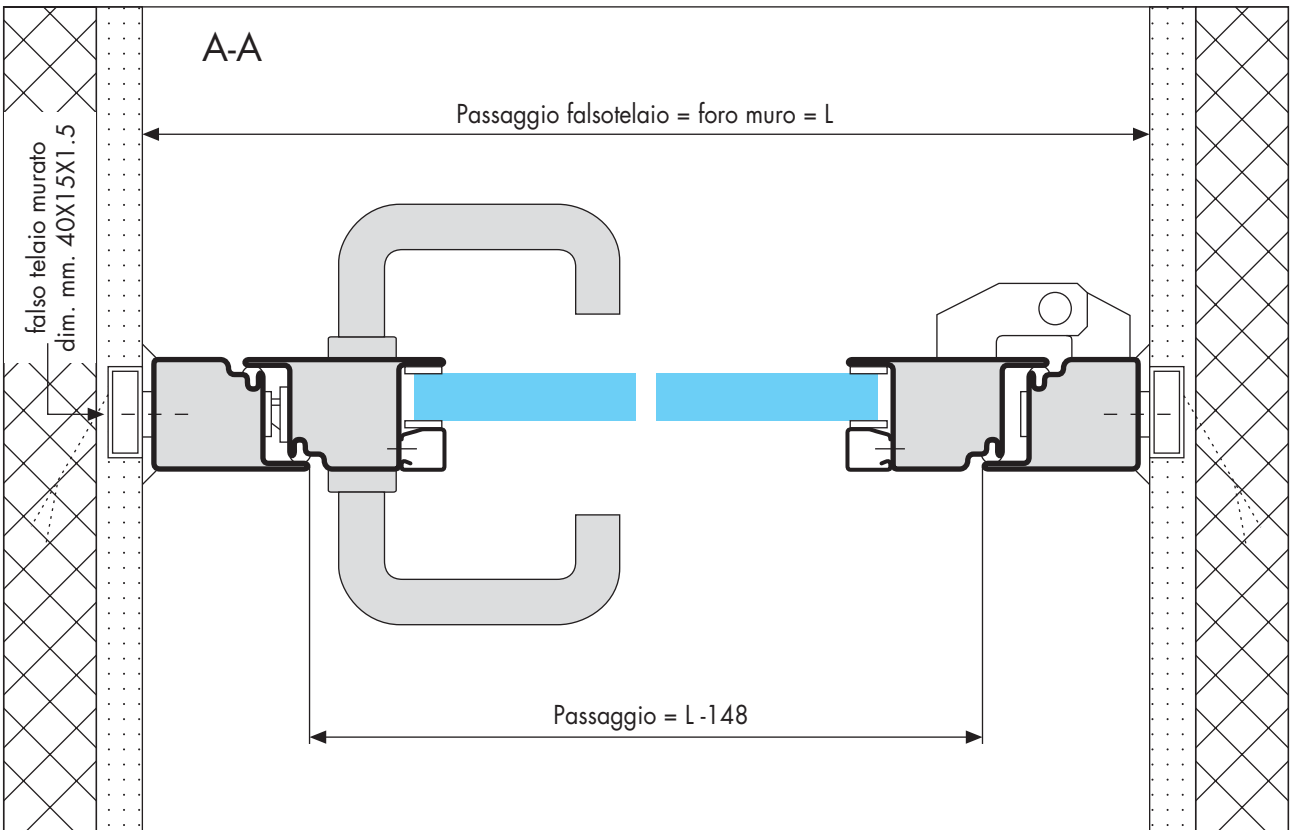

MONTAGGIO IN BATTUTA ESTERNA

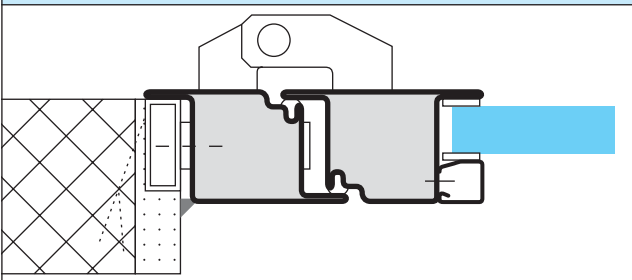

MONTAGGIO IN BATTUTA INTERNA

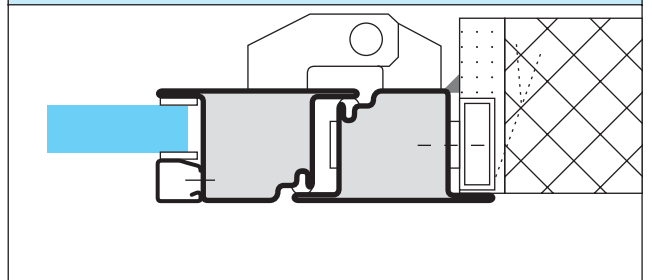

INGOMBRO ANTA A 90°

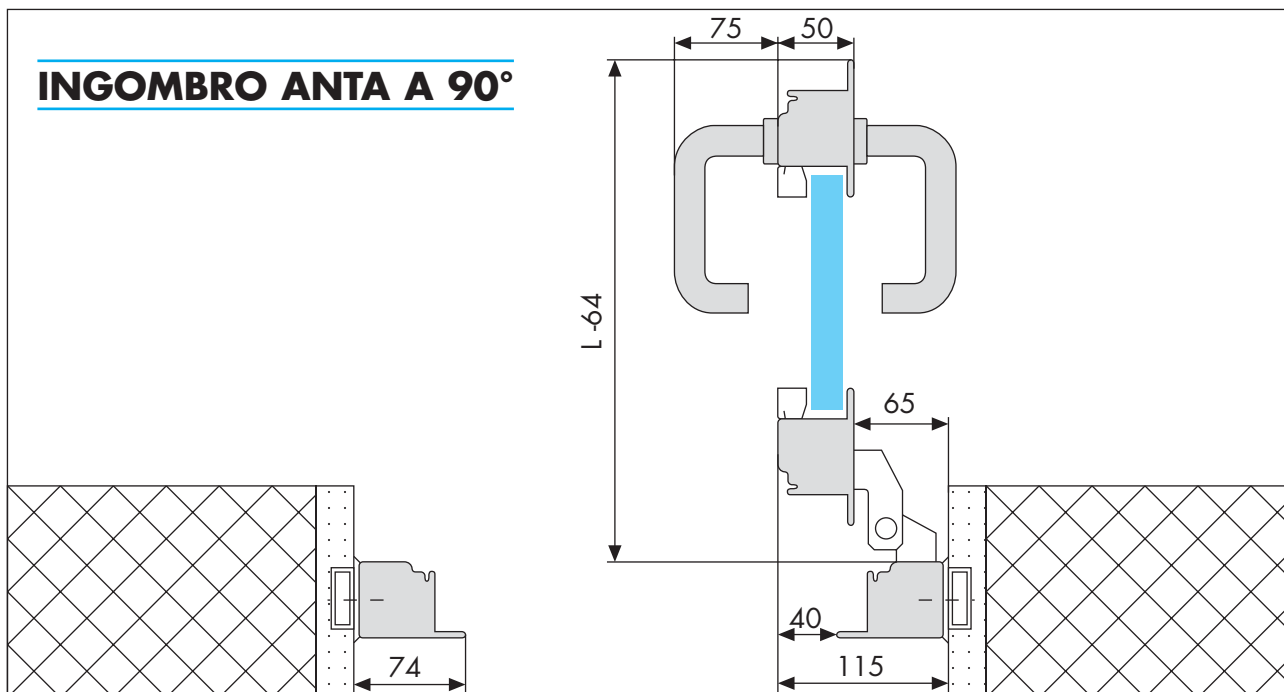

INGOMBRO A 90° CON MANIGLIONE ANTIPANICO A LEVA

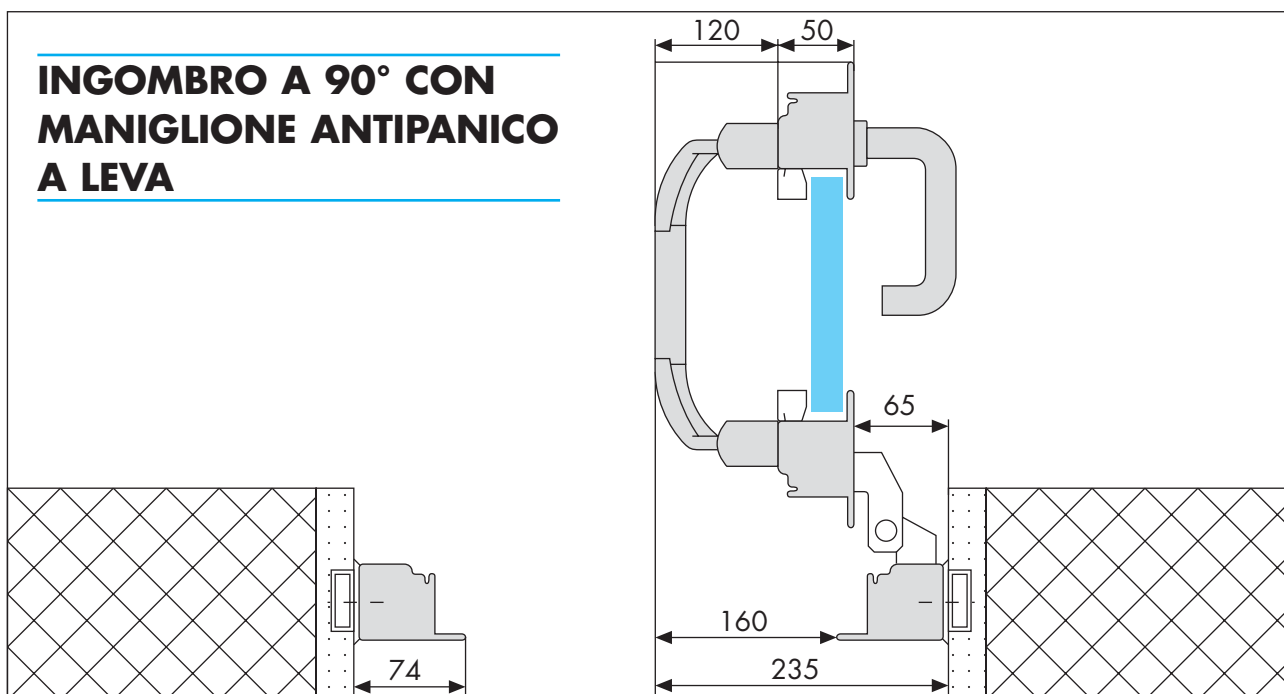

INGOMBRO A 90° CON MANIGLIONE ANTIPANICO A BARRA

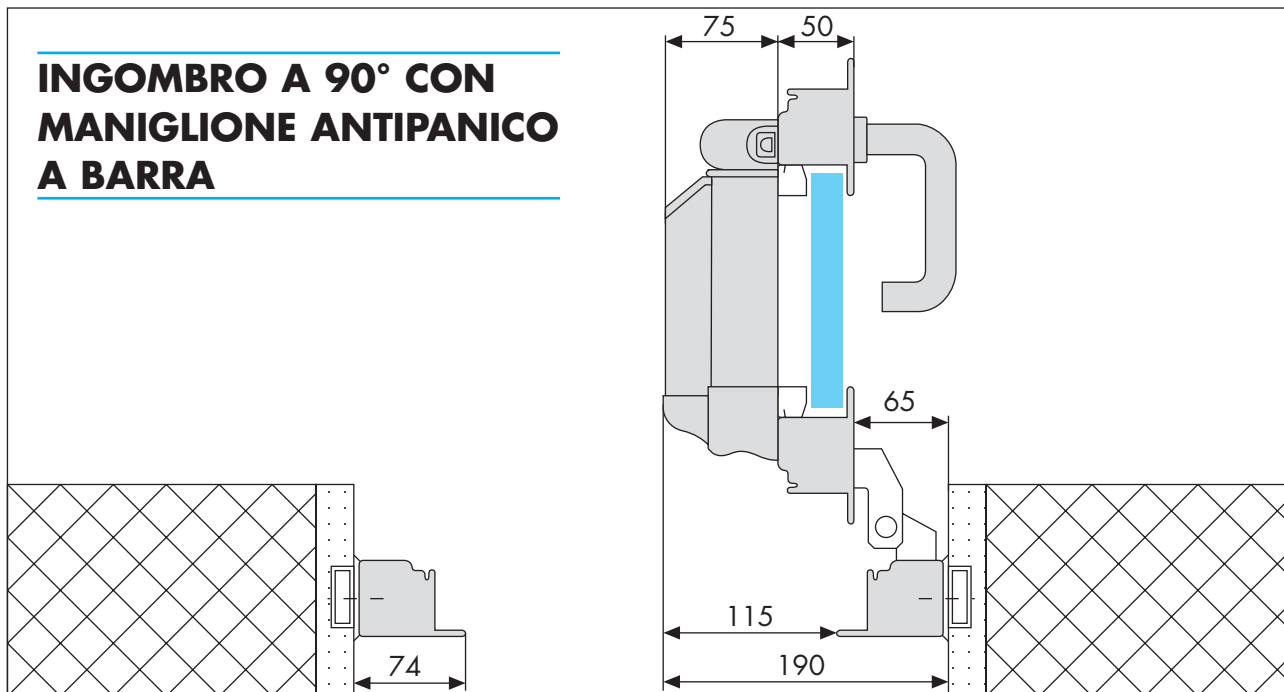

PORTA A 2 ANTE ISOSTAHL 50 REI 30 e REI 60

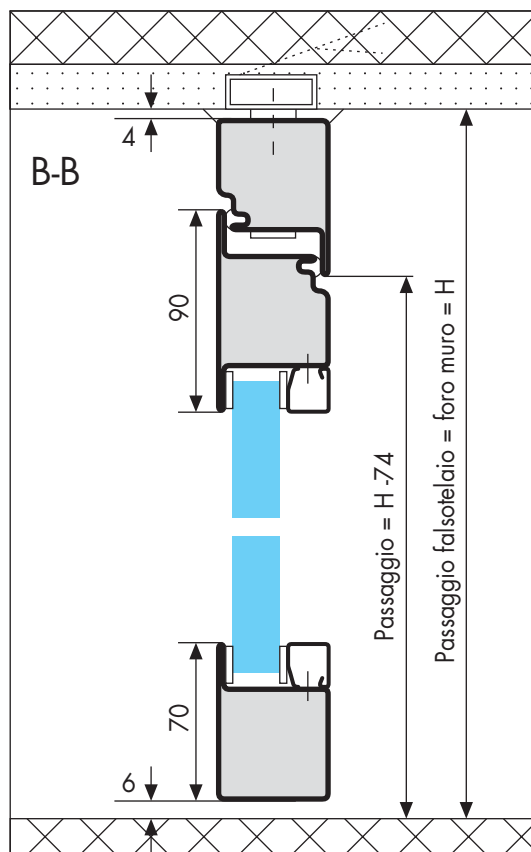
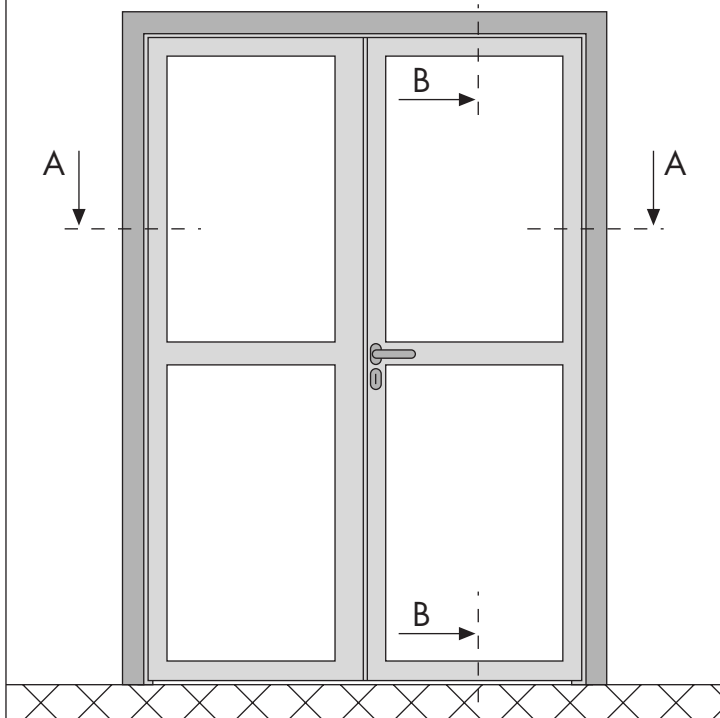

MONTAGGIO IN LUCE

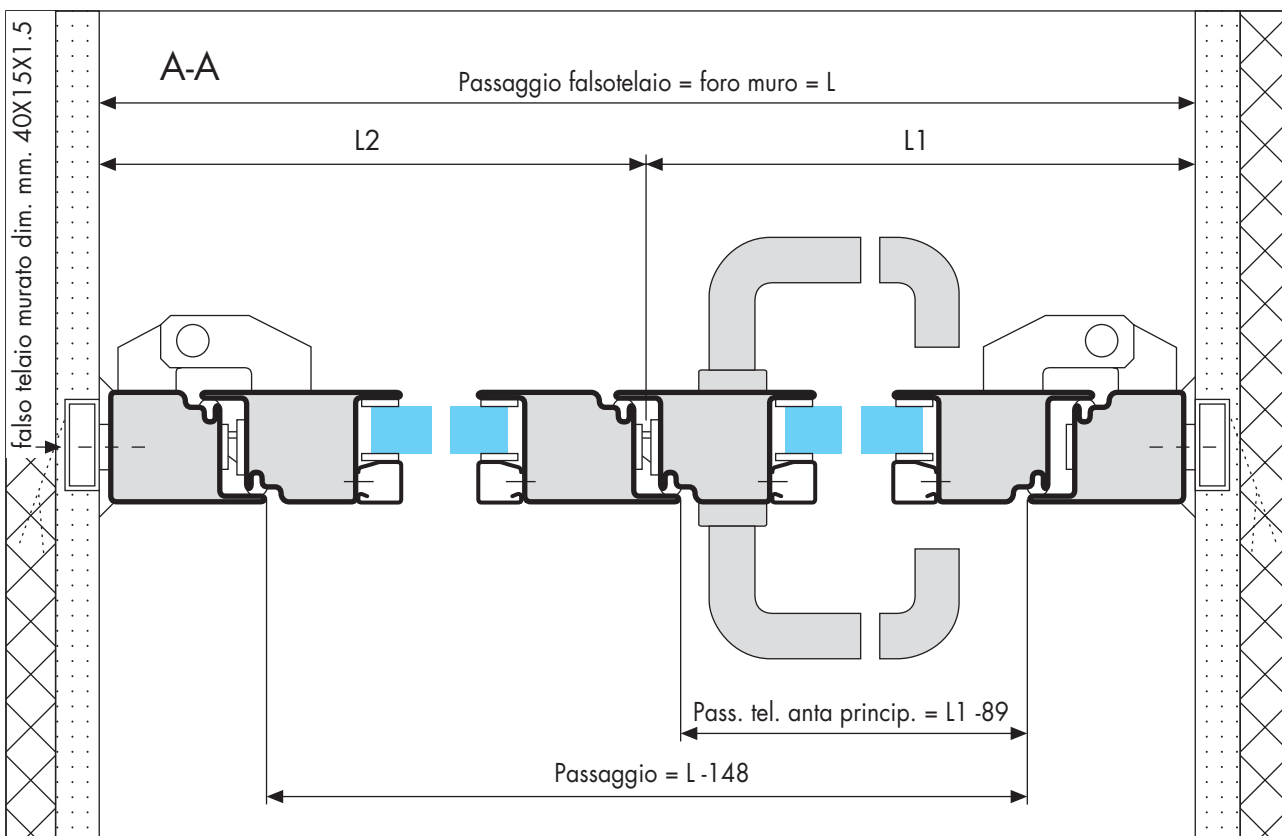

MONTAGGIO IN BATTUTA ESTERNA

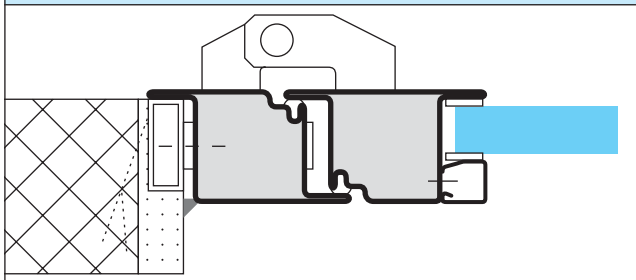

MONTAGGIO IN BATTUTA INTERNA

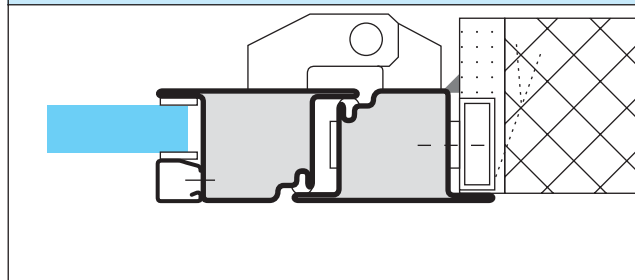

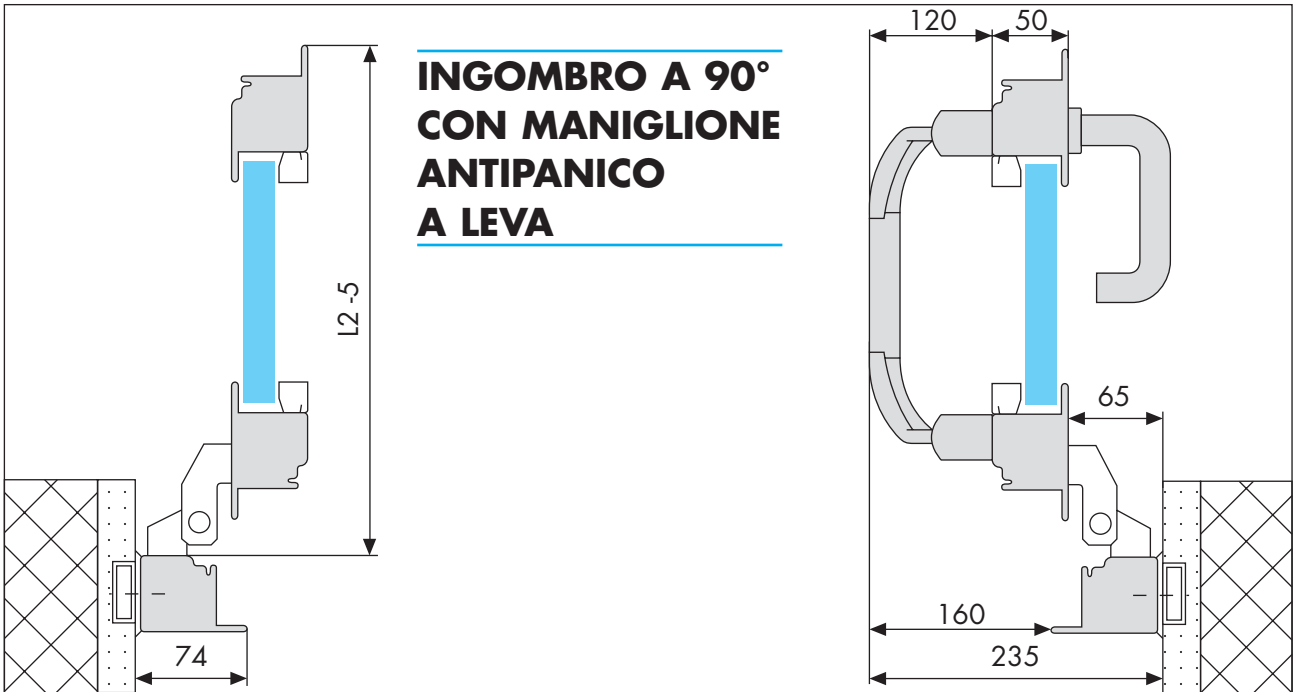
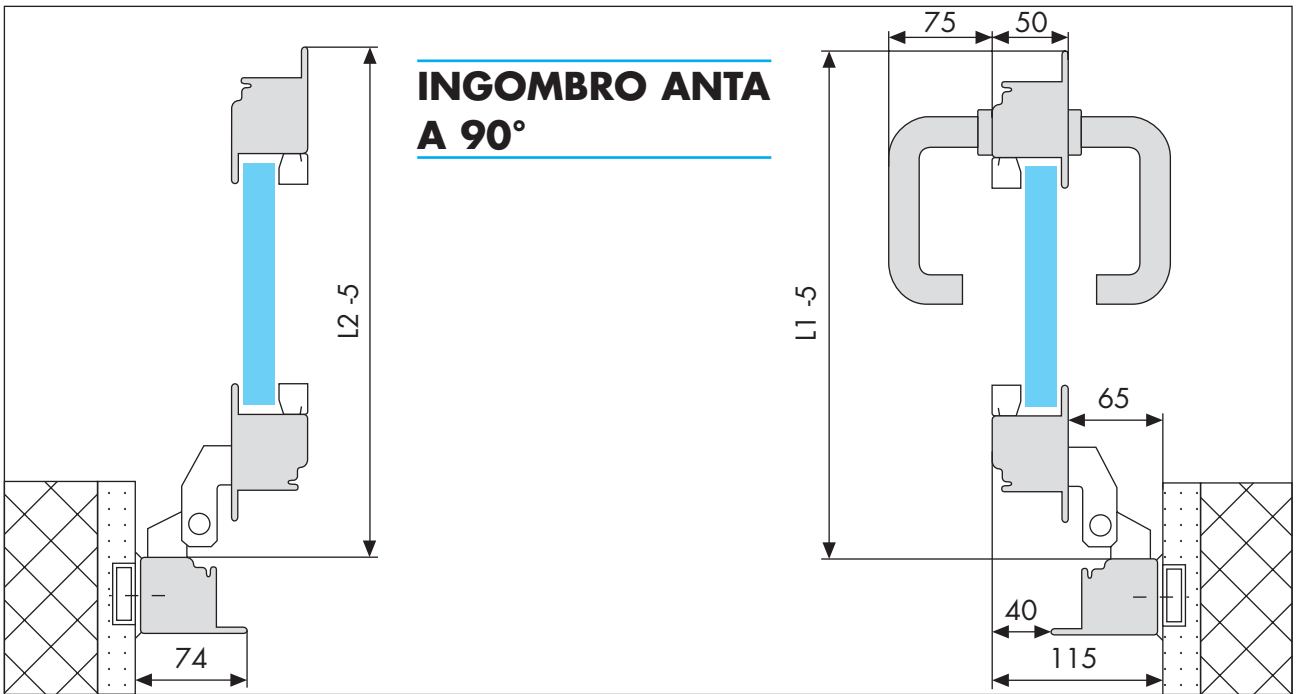

**VETRATA COMPLESSA ISOSTAHL 50
REI 30 e REI 60**

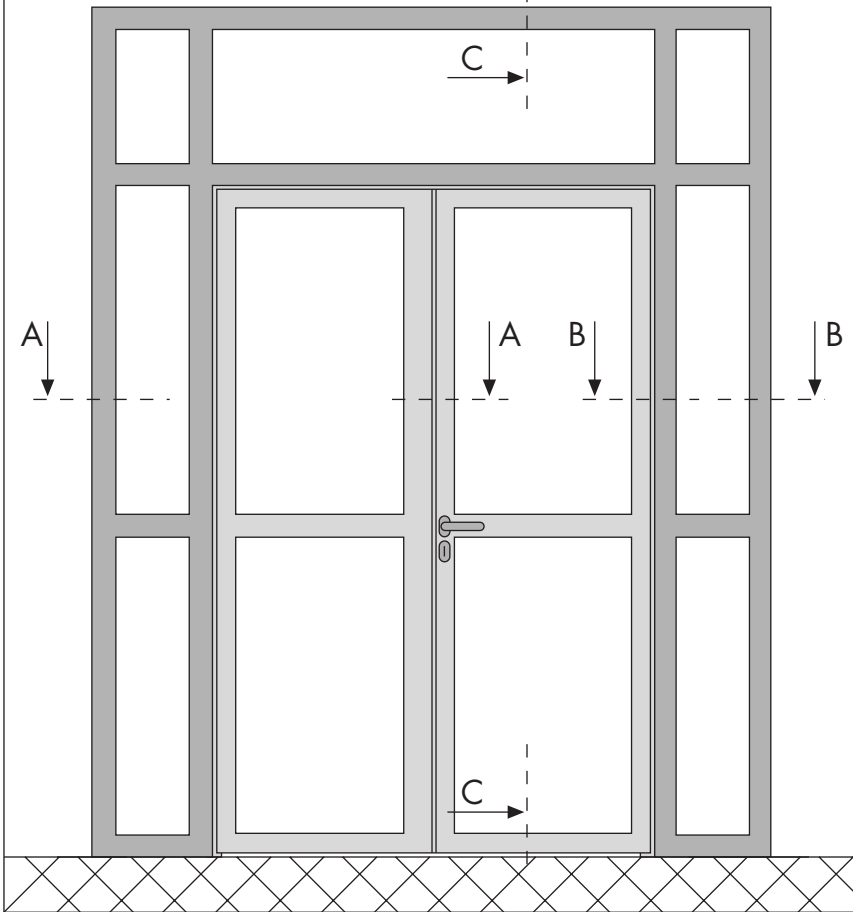

MONTAGGIO IN LUCE

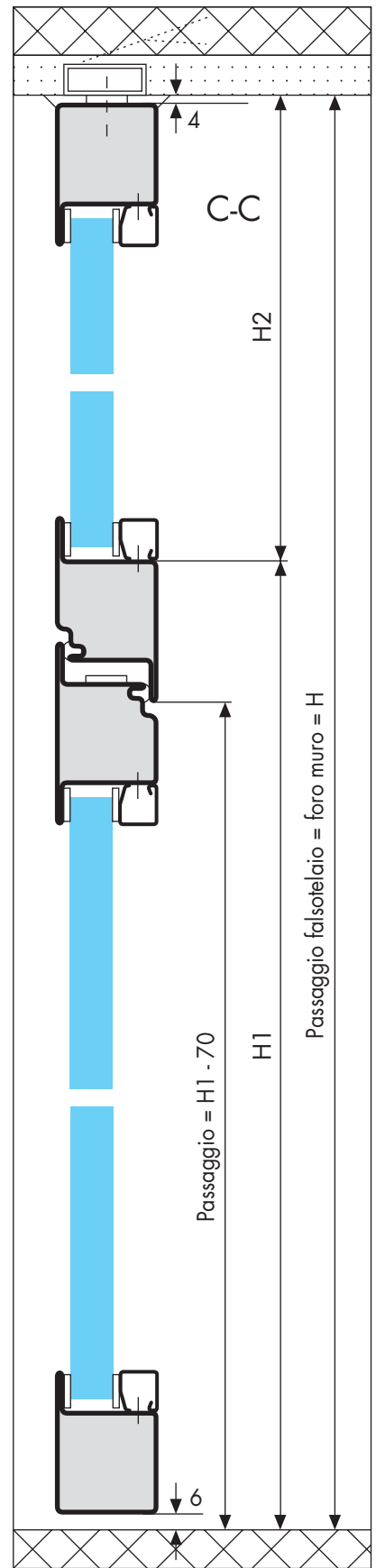
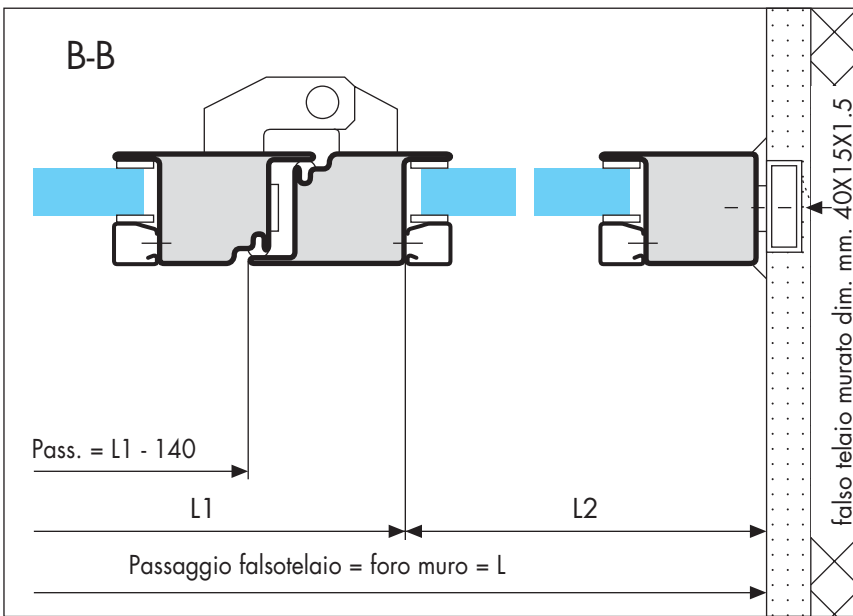

MONTAGGIO IN BATTUTA ESTERNA

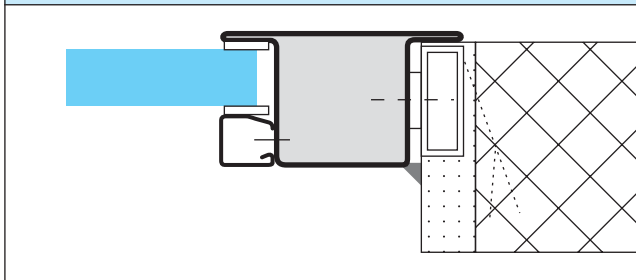

MONTAGGIO IN BATTUTA INTERNA

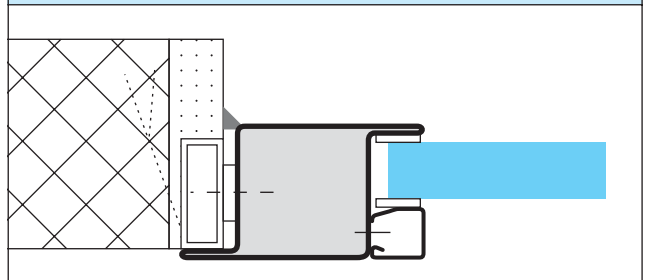

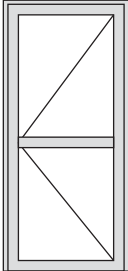
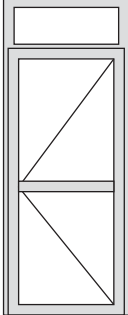
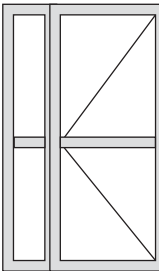
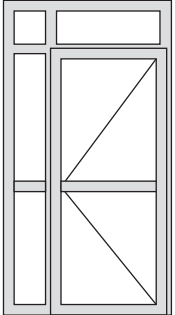
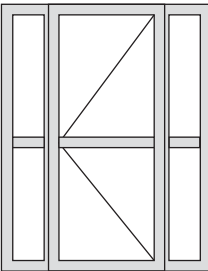
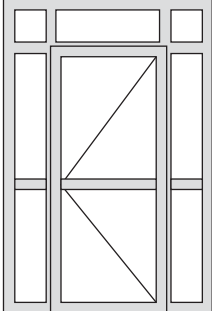
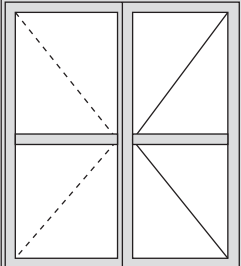
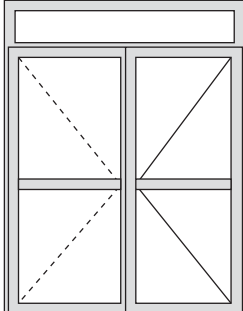
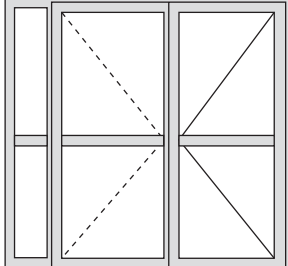
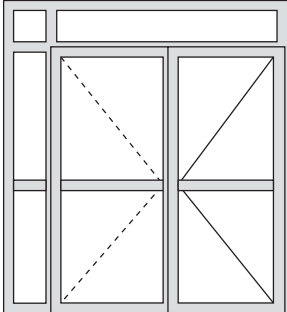
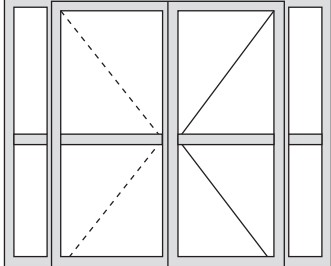
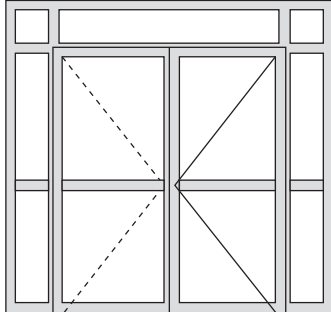
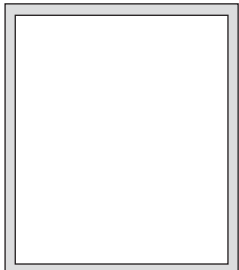
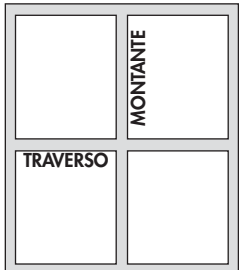
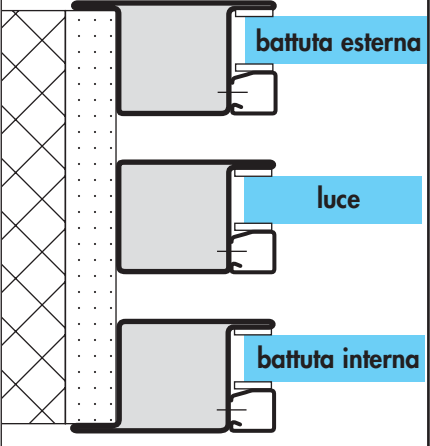
<p>PORTA AD 1 ANTA</p>  <p>A</p>	<p>PORTA AD 1 ANTA CON SOPRALUCE</p>  <p>B</p>	<p>PORTA AD 1 ANTA CON LATERALE FISSO</p>  <p>C</p>	<p>PORTA AD 1 ANTA CON LATERALE E SOPRALUCE FISSO</p>  <p>D</p>	<p>PORTA AD 1 ANTA CON DUE LATERALI FISSI</p>  <p>E</p>
<p>PORTA AD 1 ANTA CON DUE LATERALI E SOPRALUCE FISSI</p>  <p>F</p>	<p>PORTA A 2 ANTE</p>  <p>G</p>	<p>PORTA A 2 ANTE CON SOPRALUCE</p>  <p>H</p>	<p>PORTA A 2 ANTE CON LATERALE FISSO</p>  <p>I</p>	
<p>PORTA A 2 ANTE CON LATERALE E SOPRALUCE FISSI</p>  <p>L</p>	<p>PORTA A 2 ANTE CON 2 LATERALI FISSI</p>  <p>M</p>	<p>PORTA A 2 ANTE CON DUE LATERALI E SOPRALUCE FISSI</p>  <p>N</p>		
<p>FISSO A 1 SPECCHIATURA</p>  <p>O</p>	<p>FISSO A 4 SPECCHIATURE</p>  <p>P</p>	<p>ESEMPI DI POSA</p> 		
<p>Dimensioni massime: Per elemento mm. 3000x2700 • Per specchiatura lato max mm. 2000 Per specchiatura superficie massima mq. 2,4</p>				